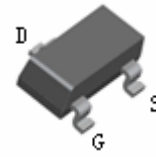


FEATURES

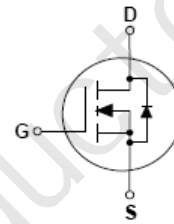
- High Density Cell Design For Low $R_{DS(ON)}$.
- Voltage Controlled Small Switch.
- Rugged and Reliable.
- High Saturation Current Capability.



SOT-23

APPLICATIONS

- N-channel enhancement mode effect transistor.
- Switching application.



ORDERING INFORMATION

Type No.	Marking	Package Code
2N7002	3P	SOT-23

MAXIMUM RATING @ Ta=25°C unless otherwise specified

Symbol	Parameter	Value	Units
V_{DSS}	Drain-Source voltage	60	V
V_{DGR}	Drain-Gate voltage($R_{GS} \leq 1M\Omega$)	60	V
V_{GSS}	Gate -Source voltage - continuous - Non Repetitive ($t_p < 50\mu s$)	± 20 ± 40	V
I_D	Maximum Drain current -continuous -Pulsed	115 800	mA
P_D	Power Dissipation	200	mW
$R_{\theta JA}$	Thermal resistance, Junction-to-Ambient	625	°C/W
T_J, T_{stg}	Junction and Storage Temperature	-55-150	°C

ELECTRICAL CHARACTERISTICS @ Ta=25°C unless otherwise specified

Parameter	Symbol	Test conditions	MIN	TYP	MAX	UNIT
Drain-Source Breakdown Voltage	$V_{(BR)DSS}$	$V_{GS}=0V, I_D=10\mu A$	60			V
Gate Threshold Voltage	$V_{GS(th)}$	$V_{DS}=V_{GS}, I_D=250\mu A$	1	2.1	2.5	
Gate-body Leakage	I_{GSS}	Forward $V_{DS}=0V, V_{GS}=20V$			100	nA
Reverse		$V_{DS}=0V, V_{GS}=-20V$			-100	
Zero Gate Voltage Drain Current	I_{DSS}	$V_{DS}=60V, V_{GS}=0V$			1	μA
		$V_{DS}=60V, V_{GS}=0V, T_J=125^\circ C$			500	
On-state Drain Current	$I_{D(on)}$	$V_{GS}=10V, V_{DS} \geq 2.0V_{DS(on)}$	500	2700		mA
Drain-Source on-voltage	$V_{DS(on)}$	$V_{GS}=10V, I_D=500mA$		0.6	3.75	V
		$V_{GS}=5V, I_D=50mA$		0.09	1.5	
Forward transconductance	g_{FS}	$V_{DS} \geq 2.0V_{DS(on)}, I_D=200mA$	80	320		mS
Static drain-Source on-resistance	$R_{DS(on)}$	$V_{GS}=10V, I_D=500mA$		1.2	7.5	Ω
		$V_{GS}=10V, I_D=500mA, T_J=100^\circ C$		1.7	13.5	
		$V_{GS}=5.0V, I_D=50mA$		1.7	7.5	
		$V_{GS}=5.0V, I_D=50mA, T_J=100^\circ C$		2.4	13.5	
Drain-Source diode forward voltage	V_{SD}	$V_{GS}=0V, I_D=115mA$		0.88	1.5	V
Input capacitance	C_{ISS}	$V_{DS}=25V, V_{GS}=0V, f=1.0MHz$		20	50	pF
Output capacitance	C_{OSS}			11	25	
Reverse transfer capacitance	C_{RSS}			4	5	
Turn-On Delay Time	$t_{D(on)}$	$V_{DD} = 30V, I_D = 0.2A,$ $R_L = 150\Omega, V_{GS} = 10V,$			20	ns
Turn-Off Delay Time	$t_{D(off)}$	$R_{GEN} = 25\Omega$			20	ns

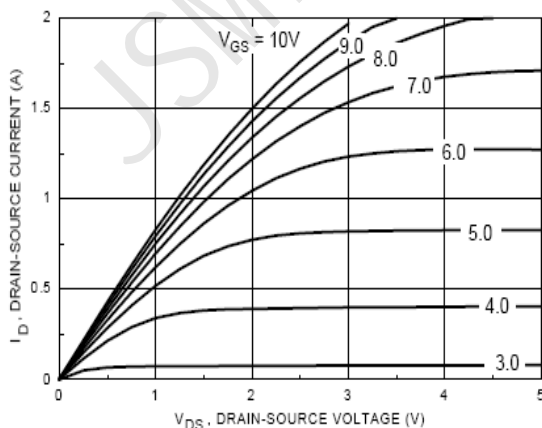
TYPICAL CHARACTERISTICS @ $T_a=25^\circ C$ unless otherwise specified


Figure 1. On-Region Characteristics

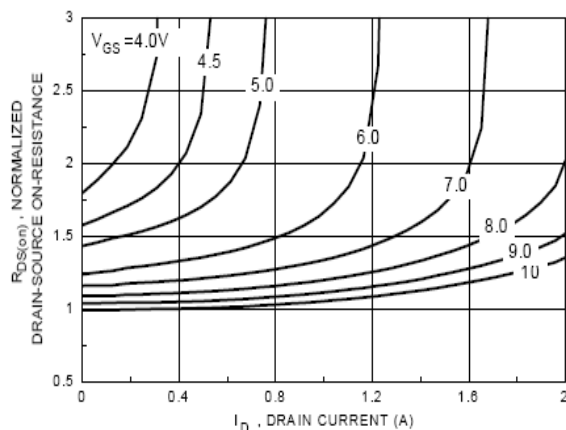


Figure 2. On-Resistance Variation with Gate Voltage and Drain Current

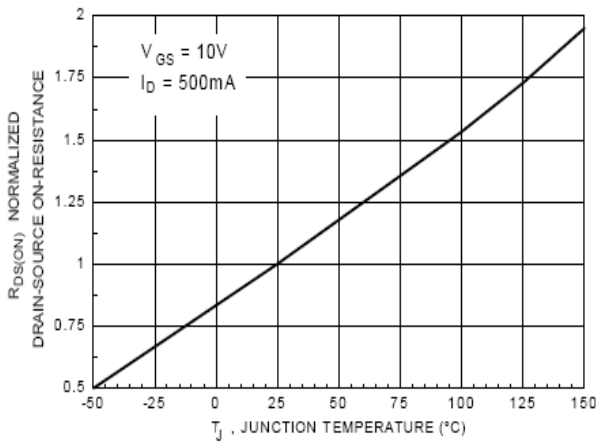


Figure 3. On-Resistance Variation with Temperature

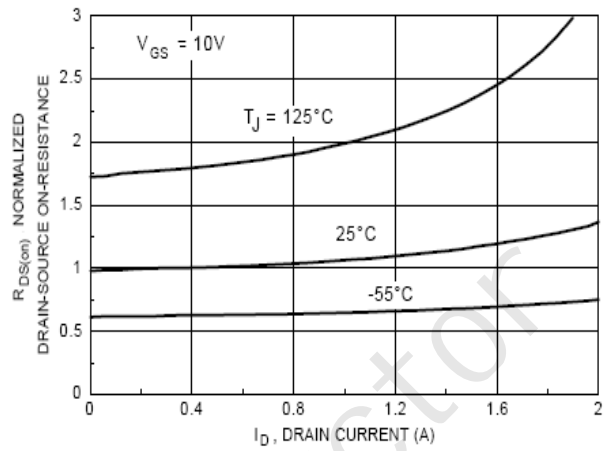


Figure 4. On-Resistance Variation with Drain Current and Temperature

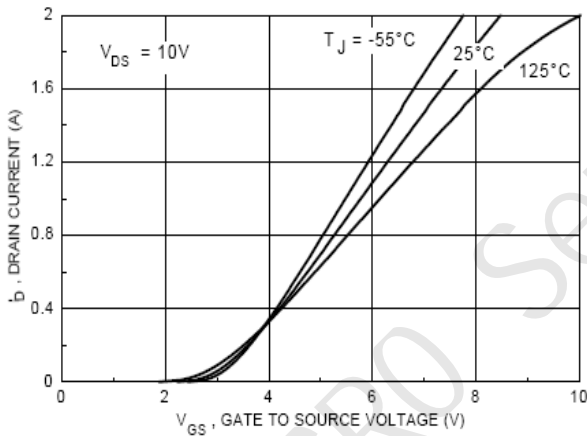


Figure 5. Transfer Characteristics

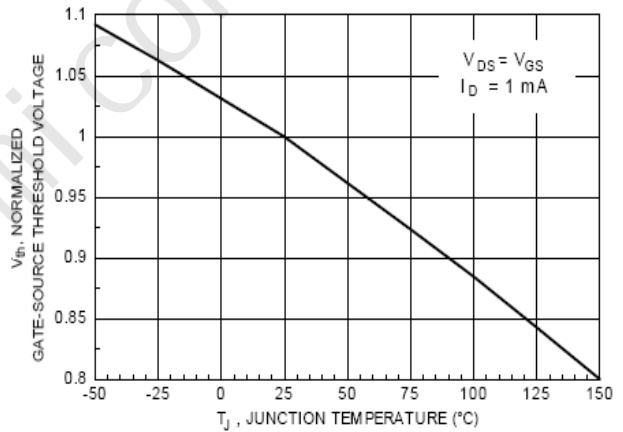


Figure 6. Gate Threshold Variation with Temperature

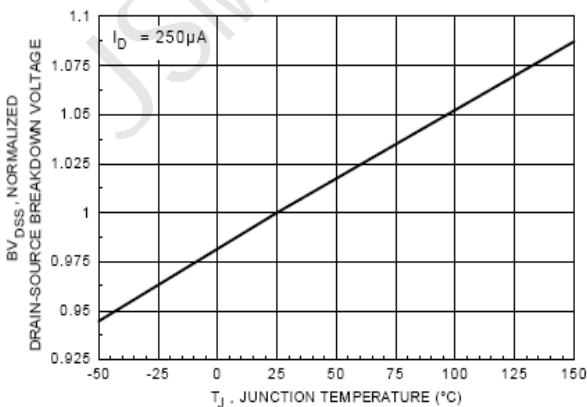


Figure 7. Breakdown Voltage Variation with Temperature

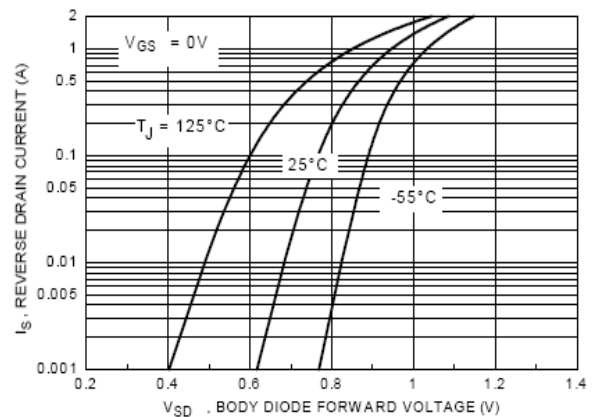
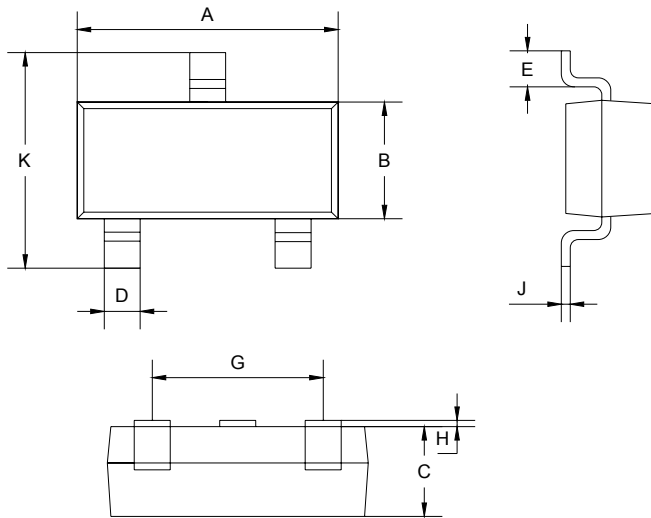


Figure 8. Body Diode Forward Voltage Variation with Temperature

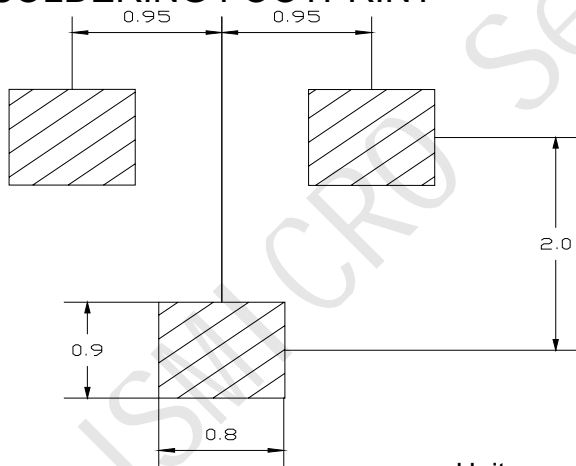
PACKAGE OUTLINE

Plastic surface mounted package

SOT-23



SOT-23		
Dim	Min	Max
A	2.85	2.95
B	1.25	1.35
C	1.0Typical	
D	0.37	0.43
E	0.35	0.48
G	1.85	1.95
H	0.02	0.1
J	0.1Typical	
K	2.35	2.45
All Dimensions in mm		

SOLDERING FOOTPRINT


Unit : mm

PACKAGE INFORMATION

Device	Package	Shipping
2N7002	SOT-23	3000/Tape&Reel